



J. Serb. Chem. Soc. 85 (8) 1055–1065 (2020)
JSCS–5359

Mass transfer process study of Fe (III) extraction from ammonium dihydrogen phosphate solution

WEIQI LI¹, HUI LIU¹, JUN LI¹, CAIXIA YOU², JIANHONG LUO^{1*} and LAN SUN^{3**}

¹Dep. of Chemical Engineering, Sichuan University, Chengdu, Sichuan, 610065, China, ²Dep. of Chemical Environment Engineering, Hebei Chemical & Pharmaceutical Vocational Technology College, Shijiazhuang, 050026, China and ³School of Manufacturing Science and Engineering, Sichuan University, Chengdu, 610065, China

(Received 17 October 2019, revised 22 May, accepted 26 May 2020)

Abstract: The crystallization of ammonium dihydrogen phosphate (MAP) is largely affected by certain metal ions such as Fe (III), and the influence seems to be pointed at both ends. Therefore, the industrial-grade MAP products can only be obtained by purifying the neutralized MAP solution from wet-process phosphoric acid (WPA). The extraction kinetics of Fe (III) from MAP solution using di-2-ethylhexyl phosphoric acid (D2EHPA) in sulfonated kerosene measured by the Lewis cell. The extraction mechanism is discussed and confirmed on the basis of the dimeric model of D2EHPA in non-polar solution. From the temperature dependence of reaction rate, the value of E_a and K_f are calculated and the extraction regimes are deduced to be mixed controlled with diffusion and chemical reaction for Fe (III). Ultimately, the rate equation for the extraction reaction of Fe (III) with D2EHPA is obtained as follows:
 $R_f = 0.028c_{Fe^{3+}}^{1.2}c_{H_2A_2}^{0.81}c_{H^+}^{-0.85}$.

Keywords: extraction kinetics; D2EHPA; Fe (III); MAP.

INTRODUCTION

The application of ammonium dihydrogen phosphate (MAP) in the field of flame retardant and drip-irrigation fertilization is wide. In the past, the high purity MAP was mainly produced by thermal-process phosphoric acid. This method, however, is costly to produce. Because of high energy consumption and environmental concerns, yellow-phosphorus manufacture factories have been closed down. This has also led to the increasing price of yellow phosphorus as the basic raw material of thermal-process phosphoric acid. Therefore, in recent years, low-cost WPA has received more attention. However, the quality of MAP products will be affected by some undesirable impurities in WPA, such as Fe (III). Puri-

*,** Corresponding authors. E-mail: (*)luojianhong@scu.edu.cn; (**)sunlan@scu.edu.cn
<https://doi.org/10.2298/JSC191017032L>

ifying WPA to manufacture superior grade MAP overcomes this problem. In general, adjusting the pH of the solution (usually 4) can remove most metal ions. But there are still some impurities such as Fe (III) left in the solution. As the results shown in Fig. 1,¹ the concentration of Fe (III) in MAP solution is about 150-300 mg L⁻¹, which has a great influence on the crystallization of MAP, and it seem to be pointed at both ends. Thereby, Fe (III) must be removed before the neutralized MAP solution can be concentrated.

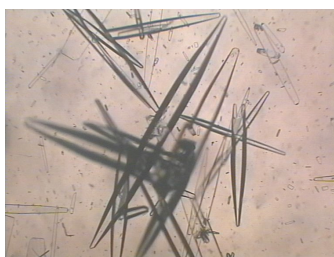

Fig. 1. The effect of Fe(III) on the MAP crystal form.

In recent years, D2EHPA, as an effective extractant²⁻⁸ has been widely used in the extraction of zinc, beryllium, copper, vanadium, indium, gallium and rare earth elements. However, most of the published literatures focus on its equilibrium properties, and there are few studies on the kinetics of liquid-liquid extraction. In addition, it is significant to study the interfacial activity of D2EHPA for the kinetics of extraction process. Thus, the extraction kinetics of Fe (III) needs to be measured as a first step towards possible separation from the MAP solution.

Here the current work aims to study the extraction kinetics of Fe (III) from MAP solution using D2EHPA in sulfonated kerosene in the Lewis cell.

MATERIALS AND METHODS

Materials

The diluent in this work is kerosene from Luo yang Zhongda Chemical Company, China (AR grade). D2EHPA is employed as an extractant produced by Luo yang Zhongda Chemical Company, China (AR grade). The ferric sulfate and phosphoric acid are provided by Ke Long Chemical Company, China (AR grade). Pure water is produced by aquapro making-water machine (ABZ1-1001-P) in our laboratory.

Analysis

The concentration of Fe (III) is determined by ultraviolet-visible spectrophotometry (MAPADA UV-1100).

Apparatus and experimental procedures

The interface area of the Lewis cell was constant, and the extraction kinetics was carried out by it. Its schematic diagram is shown in Fig. 2. In this device, the organic phase (the upper phase) and the aqueous phase (the lower phase) were stirred simultaneously to achieve countercurrent extraction of metal ions.⁹ The aqueous phase containing Fe (III) at a certain pH and the organic phase containing D2EHPA with the same mass fraction were injected into the cells without affecting the interface. The stirring speed was controlled at 75 rpm to keep the

interface stable and smooth. 1mL of the aqueous phase and 1mL of the organic phase were taken from the cells and analyzed every 15 min. The amount of Fe (III) transferred into the organic phase was estimated by the change of Fe (III) in the two phases. Unless otherwise indicated, all experiments were carried out at 343 ± 1 K. Except for the effect of specific interface area on the extraction rate, the interface area was remained at 42.4 cm^2 in most experiments.

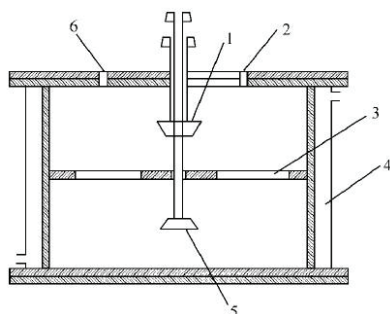
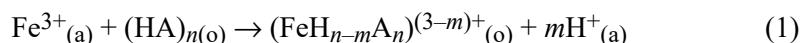

Fig. 2. The sketch of constant interfacial Lewis cell: 1. upper impeller, 2. feed inlet, 3. constant interfacial area, 4. constant temperature water jacket, 5. lower impeller and 6. sampling outlet.

RESULTS AND DISCUSSION

The Fe (III) extraction mechanism of D2EHPA from MAP solution

Since D2EHPA (HA) contains free hydrogen ions, the mechanism of extracting Fe (III) with HA may be related to cation exchange.¹⁰ In general, the extraction reaction can be described as follows:



The mark n is the aggregation number of D2EHPA and m is the number of solvent molecules of D2EHPA in extraction of complex.

The influence of hydrogen ion concentration (pH 2–4) on the distribution of Fe (III), namely the relationship between equilibrium pH and $\log D$, is shown in Fig. 3. According to Eq. (1), the extraction equilibrium constant K is described as follows:

$$K = \frac{[(\text{FeH}_{n-m}\text{A}_n)^{(3-m)+}_{(o)}][\text{H}^+]^m_{(a)}}{[\text{Fe}^{3+}]_{(a)}[(\text{HA})_{n(o)}]} \quad (2)$$

and the distribution ratio of Fe (III) is expressed as follows:

$$D = \frac{[(\text{FeH}_{n-m}\text{A}_n)^{(3-m)+}_{(o)}]}{[\text{Fe}^{3+}]_{(a)}} \quad (3)$$

$$\log D = \log (K C_{\text{HA}n(o)}) + mp\text{H} \quad (4)$$

As shown in Fig. 3, the curve of $\log D$ against pH is a straight line with a slope of about 0.263, assuming m equals to 0.25, which means that the chelate complex of $(\text{FeH}_3\text{A}_4)^{2+}_{(o)}$ can be obtained.

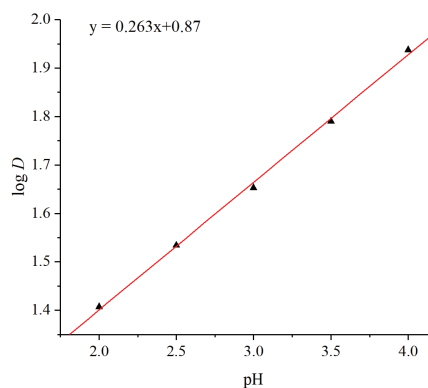
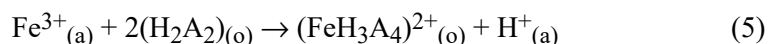

Fig. 3. The extraction distribution ratios ($\log D$) versus the initial pH of MAP solution.

Fe (III) is extracted from ammonium dihydrogen phosphate solution by D2EHPA through the following reaction:



where H_2A_2 is an organic dimer of D2EHPA, $(\text{FeH}_3\text{A}_4)^{2+}_{(o)}$ is an organic complex of the metal cation. Solvent: kerosene; phase ratio (O/A) = 1:3; D2EHPA volume fraction: 30 %; agitation speed: 45 rpm; initial Fe (III) concentration: 180 mg L^{-1} ; stirring time: 30 min; reaction temperature: $60 \text{ }^\circ\text{C}$.

The extraction kinetics of Fe (III) with D2EHPA

Assuming that the mass-transfer process can be formally regarded as a pseudo-first order reversible reaction to a metal cation, the following equation can be written as:^{11,12}

$$R_f = -\frac{dc_{\text{Fe}^{3+}}}{A dt} = K_f c_{\text{Fe}^{3+}}^a c_{\text{H}_2\text{A}_2}^b c_{\text{H}^+}^c \quad (6)$$

where K_f represents the extraction rate constant, a , b and c represent the reaction sequence relative to Fe (III), H_2A_2 and H^+ , respectively. A is the interfacial area. “[]” and “[]_(o)” represent the concentration of substances in the aqueous and organic phase, respectively.

Then, Eq. (6) takes the form:

$$\log R_f = \log K_f + a \log c_{\text{Fe}^{3+}} + b \log c_{\text{H}_2\text{A}_2} + c \log c_{\text{H}^+} \quad (7)$$

From Eq. (6), $R_f = -dc_{\text{Fe}^{3+}}/A dt$, R_f are the extraction rate, A is constant value.

The following equation can be written by taking the logarithmic form as Eq. (8) in the case of constant extractant concentrations and aqueous acidity C_{H} , varying Fe (III) concentrations:

$$\log R_f = \log (K_f c_{\text{H}_2\text{A}_2}^b c_{\text{H}^+}^c) + a \log c_{\text{Fe}^{3+}} \quad (8)$$

The sequence of Fe (III) reactions can be obtained by knowing the values of a set of R_f .

Analogously, under the condition of constant initial Fe (III) concentrations and aqueous acidity C_H , and variable extractant concentrations, the following equation can be obtained as:

$$\log R_f = \log (K_f \log c_{Fe^{3+}}^a c_{H^+}^c) + b \log c_{H_2A_2} \quad (9)$$

Finally, under the condition of constant initial Fe (III) concentrations, extractant concentrations and variable aqueous pH, the equation as follows can be obtained:

$$\log R_f = \log (K_f \log c_{Fe^{3+}}^a c_{H_2A_2}^b) + c \log c_{H^+} \quad (10)$$

After getting the values of a , b and c , the rate constant K_f can be calculated simultaneously from the slopes of Eqs. (8)–(10).¹³

Once the sequence of reactions of the species involved is known, the extraction rate equation of Fe (III) from ammonium dihydrogen phosphate solution can be formed.

Effect of Fe (III) concentrations on extraction rates

Measuring the changes of Fe (III) concentrations per min on the unit interface area, which is denoted by symbol $I_{Fe^{3+}}$ in the aqueous phase, at various initial Fe (III) concentrations leads to the results shown in Fig. 4. In all cases studied, curves of Fe (III) concentration versus time are linear and the extraction rates have been measured at various initial Fe (III) concentrations, which are shown in Fig. 5.

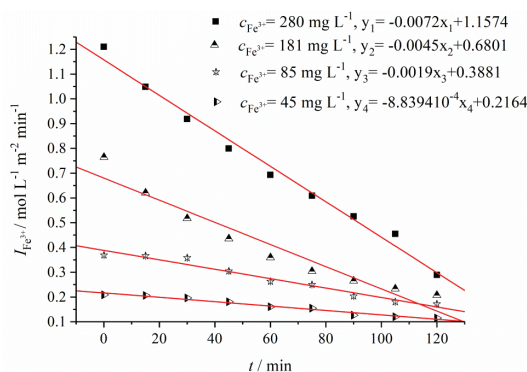

Fig. 4. The Fe (III) concentrations effect on the kinetics; D2EHPA concentration: 0.91 mol L⁻¹; agitation speed: 75 rpm; reaction temperature: 343 K; $A = 24.2$ cm²; initial pH of MAP: 2.54.

The relationship between $\log c_{Fe^{3+}}$ and $\log R_f$ is linear, indicating that, according to the Eq. (8), the order of reactions in the extraction with respect to $c_{Fe^{3+}}$ is 1.2. The results show that the extraction rate is directly proportional to Fe (III) concentration in aqueous solution.

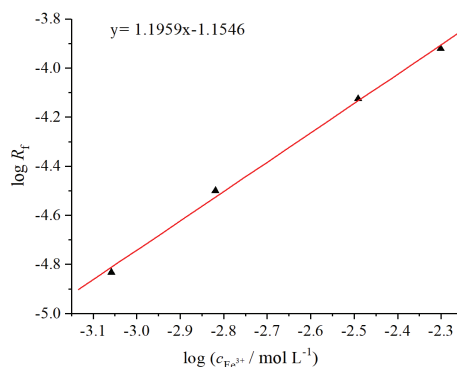

Fig. 5. The effect of Fe (III) concentration on the extraction rate; D2EHPA concentration: 0.91 mol L^{-1} ; agitation speed: 75 rpm ; reaction temperature: 343 K ; $A = 24.2 \text{ cm}^2$; initial pH of MAP: 2.54 .

Effect of extractant concentrations on extraction rates

In all cases investigated, plots of Fe (III) concentrations *versus* time are straight lines as shown in Fig. 6. In Fig. 7, it can be seen that the extraction rate increases linearly with the rise of extractant concentration. Within the range of extractant concentration, the slope of $\log R_F$ *versus* $\log c_{\text{HA}}$ curve is close to 0.81 .

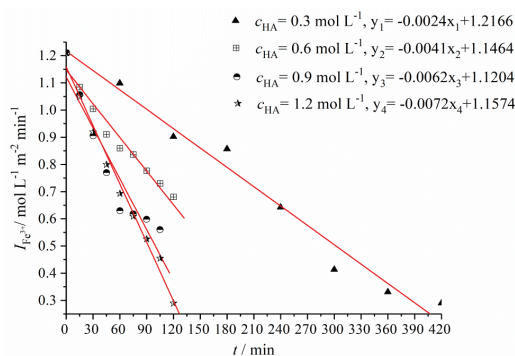

Fig. 6. The extractant concentrations effect on the kinetics; agitation speed: 75 rpm ; Initial Fe (III) concentration: 280 mg L^{-1} ; reaction temperature: 343 K ; $A = 24.2 \text{ cm}^2$; initial pH of MAP: 2.54 .

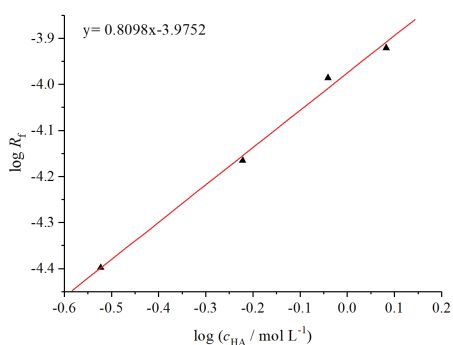

Fig. 7. The effect of D2EHPA concentration on the extraction rate; Agitation speed: 75 rpm ; initial Fe (III) concentration: 280 mg L^{-1} ; reaction temperature: 343 K ; $A = 24.2 \text{ cm}^2$; initial pH of MAP: 2.54 .

Effect of pH on extraction rates

Fig. 8 represents the variation of Fe (III) concentrations in the aqueous phase at four different hydrogen ion concentrations. For pH 2.29, 2.54, 2.79 and 3.04 systems, the slopes of the straight lines are -0.0044 , -0.0072 , -0.0111 and $-0.0195 \text{ mol L}^{-1} \text{ m}^{-2} \text{ min}^{-2}$, respectively.

According to Eq. (10), the value 0.85 for the order of hydrogen ion reaction can be estimated in Fig. 9. Under all experimental conditions, the slope is almost identical, indicating that the rate of Fe (III) extraction from the aqueous phase to the organic phase is directly proportional to the concentration of D2EHPA in the organic phase.

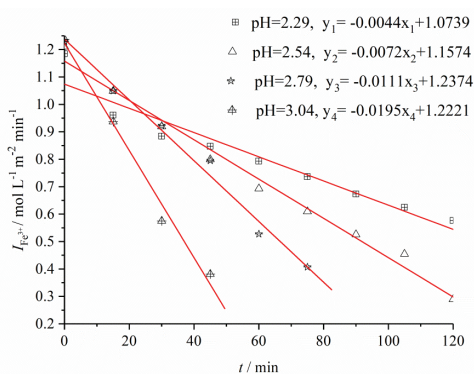

Fig. 8. The pH effect on the kinetics; D2EHPA concentration: 0.91 mol L^{-1} ; agitation speed: 75 rpm ; initial Fe (III) concentration: 280 mg L^{-1} ; reaction temperature: 343 K ; $A = 24.2 \text{ cm}^2$.

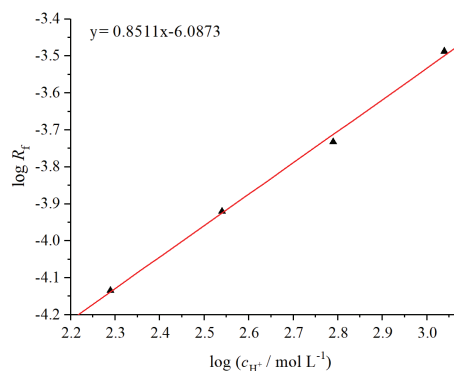

Fig. 9. The effect of pH of MAP solution on the extraction rate; D2EHPA concentration: 0.91 mol L^{-1} ; Agitation speed: 75 r min^{-1} ; Initial Fe (III) concentration: 280 mg L^{-1} ; Reaction temperature: 343 K ; $A = 24.2 \text{ cm}^2$

Effect of temperature on extraction rates

The influence of the temperature on the extraction rates is investigated over the temperature range of 318 to 353 K . It can be seen from Figs. 10 and 11 that the extraction rate increases with temperature. According to the Arrhenius law, calculated from the slope of $\log R_f$ versus $1000/T$ in Fig. 11, the apparent activation energy E_a of the extraction is 33.9 kJ mol^{-1} .

Generally, if the rate is controlled by the chemical reaction, E_a is more than 42 kJ mol^{-1} . If the rate is controlled by the diffusion process, E_a is less than 20 kJ mol^{-1} . And the E_a value between 42 and 20 kJ mol^{-1} , which is expected for the mixed control scheme.¹⁴ Thus, it is recommended that the extraction kinetics of Fe (III) with D2EHPA proceeds under mixed conditions.

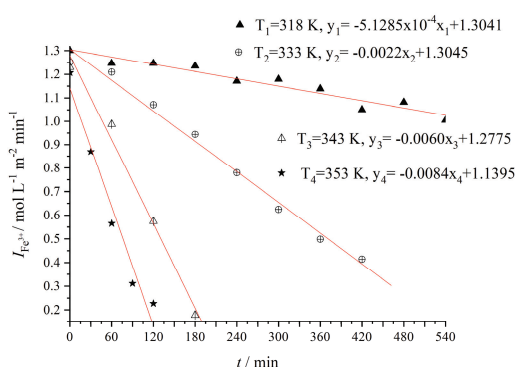

Fig. 10. The temperature effect on the kinetics; D2EHPA concentration: 0.91 mol L^{-1} ; agitation speed: 75 rpm ; initial Fe (III) concentration: 280 mg L^{-1} ; $A = 24.2 \text{ cm}^2$; initial pH of MAP: 2.54 .

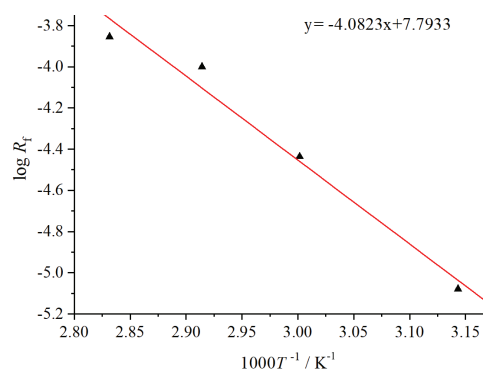

Fig. 11. The effect of temperature on the extraction rate; D2EHPA concentration: 0.91 mol L^{-1} ; agitation speed: 75 rpm ; initial Fe (III) concentration: 280 mg L^{-1} ; $A = 24.2 \text{ cm}^2$; initial pH of MAP: 2.54 .

The values of $a = 1.2$, $b = 0.81$, $c = -0.85$ and the experimental data shown in Figs. 6 and 7, can be used to evaluate the mass transfer coefficient as 0.028 s^{-1} at the temperature of 343.15 K .

Effect of interfacial area on extraction rates

The effect of the interfacial area on the extraction rates is studied and the result is shown in Figs. 12 and 13. It has been reported that¹⁵ if the slow chemical reaction occurs in the bulk phase, the initial rate will have no connection with the interfacial area. Instead, the reaction at the interface will show a direct proportional relationship between the rate and the area of the interface. The effects of the interfacial areas on the extraction rates are studied with approximated linear relationships obtained (Fig. 13), which clearly indicates that the extraction reaction occurs at the liquid–liquid interface.

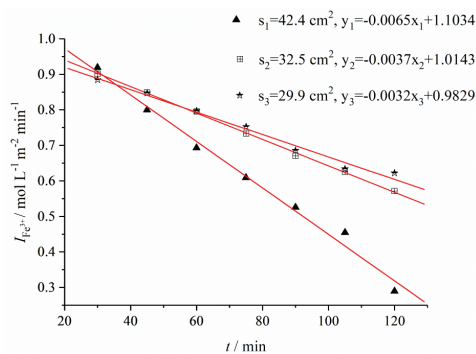

Fig. 12. The interfacial area effect on the kinetics; D2EHPA concentration: 0.91 mol L⁻¹; agitation speed: 75 rpm; initial Fe (III) concentration: 280 mg L⁻¹; reaction temperature: 343 K; initial pH of MAP: 2.54.

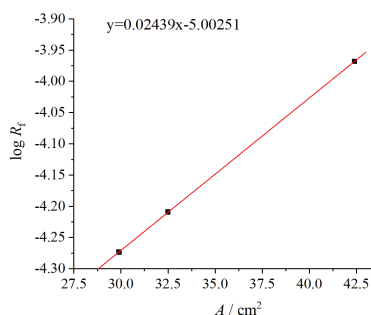
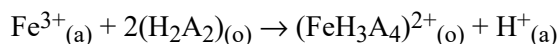

Fig. 13. The effect of interfacial area on the extraction rate; D2EHPA concentration: 0.91 mol L⁻¹; agitation speed: 75 rpm; initial Fe (III) concentration: 280 mg L⁻¹; reaction temperature: 343 K; initial pH of MAP: 2.54.

CONCLUSIONS

The following conclusions can be drawn in this study:

1. The mechanism of the extraction of Fe (III) with H₂A₂ is consistent with cation exchange and chelation reactions as follows:



At the temperature of 343.15 K, the rate equations is written as:

$$R_f = 0.028C_{Fe^{3+}}^{1.2}C_{H_2A_2}^{0.81}C_{H^+}^{-0.85}$$

2. The extraction rate is directly proportional to Fe (III) concentration in aqueous solution. In the pH range of 2 to 4, the rate of Fe (III) extraction from the aqueous phase to the organic phase is directly proportional to the concentration of D2EHPA in the organic phase. The extraction rate increases with temperature (from 318 to 353 K) and the extractant concentration (from 45 to 280 mg L⁻¹). The reaction at the interface will show a direct proportional relationship between the extraction rate and the area of the interface (from 30 to 42.5 cm²).

3. The extraction of Fe (III) is a mixing process in which diffusion rate and chemical reaction rate may be considered together as rate-determining steps.

Acknowledgement. The authors gratefully acknowledge financial support from the Chinese National Natural Science Foundation (21776181), Sichuan University innovation spark

project (2018SCUH0012) and National Key R&D Program of China (2018YFC1900203-03) and 2018CDPZH-12.

ИЗВОД

ИСПИТИВАЊЕ ПРЕНОСА МАСЕ ПРОЦЕСА ЕХСТРАКЦИЈЕ Fe (III) ИЗ РАСТВОРА АМОНИЈУМ-ДИХИДРОГЕН-ФОСФАТА

WEIQI LI¹, HUI LIU¹, JUN LI¹, CAIXIA YOU², JIANHONG LUO¹ и LAN SUN³

¹Dep. of Chemical Engineering, Sichuan University, Chengdu, Sichuan, 610065, China, ²Dep. of Chemical Environment Engineering, Hebei Chemical & Pharmaceutical Vocational Technology College, Shijiazhuang, 050026, China и ³School of Manufacturing Science and Engineering, Sichuan University, Chengdu, 610065, China

На кристализацију амонијум-дихидроген-фосфата (МАР) значајно утичу одређени метални јони као што је Fe (III). Због тога се МАР производ индустријског квалитета може добити пречишћавањем неутрализованог МАР раствора из фосфорне киселине добијене мокрим поступком (WPA). Кинетика екстракције Fe (III) из МАР раствора коришћењем ди-2-етилхексил-фосфорне киселине (D2ЕНРА) у сулфонираном керозину је мерена коришћењем Луисове ћелије. Механизам екстракције је дискутован и потврђен на основу модела димера D2ЕНРА у неполарном раствору. Из температурне зависности мерења брзине израчунате су вредности E_a и K_f и установљено је да је екстракциони режим мешовито контролисан дифузијом и хемијском реакцијом Fe (III). Коначно, једначина брзине за реакцију екстракције Fe (III) помоћу D2ЕНРА се добија у следећем облику: $R_f = 0,028 C_{Fe^{3+}}^{1,2} C_{CH_2A_2}^{0,81} C_{CH^+}^{-0,85}$.

(Примљено 17. октобра 2019, ревидирано 22. маја, прихваћено 26. маја 2020)

REFERENCES

1. S. D. Wang, H. Y. Zhang, J. Li, *Inorg. Chem. Ind.* **4** (2008) 39 (<http://www.wjygy.com.cn/CN/abstract/abstract163.shtml>)
2. S. T. Kuang, Z. F. Zhang, Y. L. Li, H. Q. Wei, W. P. Liao, *Hydrometallurgy* **174** (2017) 78 (<https://dx.doi.org/10.1016/j.hydromet.2017.09.011>)
3. Y. C. Hoh, W. S. Chuang, B. D. Lee, C. C. Chang, *Hydrometallurgy* **12** (1984) 375 ([https://dx.doi.org/10.1016/0304-386X\(84\)90008-2](https://dx.doi.org/10.1016/0304-386X(84)90008-2))
4. A. M. Chekmarev, E. S. Kondratyeva, V. A. Kolesnikov, Gubin, A. F., *Dokl. Chem.* **464** (2015) 221 (<https://dx.doi.org/10.1134/S0012500815090013>)
5. Y. Liu, M. Lee, *J. Ind. Eng. Chem.* **28** (2015) 322 (<https://dx.doi.org/10.1016/j.jiec.2015.03.010>)
6. K. K. Sahu, R. P. Das, *Metall. Mater. Trans., B* **31** (2000) 1169 (<https://dx.doi.org/10.1007/s11663-000-0003-5>)
7. B. H. Yao, N. Yukio, S. Masatada, N. Akihiko, H. Kiyoshi, *Solvent Extr. Ion Exch.* **14** (1996) 849 (<http://dx.doi.org/10.1080/07366299608918372>)
8. J. P. Simonin, H. Hendrawan, F. Dardoize, G. Clodic, *Hydrometallurgy* **69** (2003) 23 ([http://dx.doi.org/10.1016/S0304-386X\(02\)00211-6](http://dx.doi.org/10.1016/S0304-386X(02)00211-6))
9. Z. Zheng, J. Lu, D. Q. Li, G. X. Ma, *Chem. Eng. Sci.* **53** (1998) 2327 ([http://dx.doi.org/10.1016/S0009-2509\(98\)00067-0](http://dx.doi.org/10.1016/S0009-2509(98)00067-0))
10. I. Van de Voorde, L. Pinoy, E. Courtijn, F. Verpoort, *Hydrometallurgy* **78** (2005) 92 (<http://dx.doi.org/10.1016/j.hydromet.2005.02.008>)
11. R. K. Biswas, M. G. K. Mondal, *Hydrometallurgy* **69** (2003) 117 ([http://dx.doi.org/10.1016/S0304-386X\(02\)00208-6](http://dx.doi.org/10.1016/S0304-386X(02)00208-6))

12. F. Islam, R. K. Biswas, *J. Inorg. Nucl. Chem.* **40** (1978) 559
([http://dx.doi.org/10.1016/0022-1902\(78\)80442-4](http://dx.doi.org/10.1016/0022-1902(78)80442-4))
13. D. B. Wu, X. L. Wang, D. Q. Li, *Chem. Eng. Process.* **46** (2007) 17
(<http://dx.doi.org/10.1016/j.cep.2006.04.007>)
14. D. B. Wu, Y. Xiong, D. Q. Li, *Hydrometallurgy* **82** (2006) 176
(<http://dx.doi.org/10.1016/j.hydromet.2006.03.042>)
15. P. R. Danesi, R. Chiarizia, C. F. Coleman, *Crit. Rev. Anal. Chem.* **10** (1980) 1
(<http://dx.doi.org/10.1080/10408348008085494>).